

NTGD4167C

Power MOSFET

Complementary, 30 V, +2.9/-2.2 A,
TSOP-6 Dual

Features

- Complementary N-Channel and P-Channel MOSFET
- Small Size (3 x 3 mm) Dual TSOP-6 Package
- Leading Edge Trench Technology for Low On Resistance
- Reduced Gate Charge to Improve Switching Response
- Independently Connected Devices to Provide Design Flexibility
- This is a Pb-Free Device

Applications

- DC-DC Conversion Circuits
- Load/Power Switching with Level Shift

MAXIMUM RATINGS (T_J = 25°C unless otherwise noted)

Parameter		Symbol	Value	Unit
Drain-to-Source Voltage		V _{DSS}	30	V
Gate-to-Source Voltage (N-Ch & P-Ch)		V _{GS}	±12	V
N-Channel Continuous Drain Current (Note 1)	Steady State T _A = 25°C T _A = 85°C	I _D	2.6 1.9	A
	t ≤ 5 s T _A = 25°C		2.9	
P-Channel Continuous Drain Current (Note 1)	Steady State T _A = 25°C T _A = 85°C	I _D	-1.9 -1.4	A
	t ≤ 5 s T _A = 25°C		-2.2	
Power Dissipation (Note 1)	Steady State T _A = 25°C	P _D	0.9	W
	t ≤ 5 s		1.1	
Pulsed Drain Current	N-Ch P-Ch	I _{DM}	8.6 -6.3	A
	t _p = 10 μs			
Operating Junction and Storage Temperature		T _J , T _{STG}	-55 to 150	°C
Source Current (Body Diode)		I _S	±0.9	A
Lead Temperature for Soldering Purposes (1/8" from case for 10 s)		T _L	260	°C

THERMAL RESISTANCE RATINGS

Parameter	Symbol	Value	Unit
Junction-to-Ambient – Steady State (Note 1)	R _{θJA}	140	°C/W
Junction-to-Ambient – t ≤ 5 s (Note 1)	R _{θJA}	110	°C/W

Stresses exceeding Maximum Ratings may damage the device. Maximum Ratings are stress ratings only. Functional operation above the Recommended Operating Conditions is not implied. Extended exposure to stresses above the Recommended Operating Conditions may affect device reliability.

1. Surface Mounted on FR4 Board using 1 in sq pad size (Cu area = 1.127 in sq [1 oz] including traces).



ON Semiconductor®

<http://onsemi.com>

V _{(BR)DSS}	R _{DS(on)} MAX	I _D MAX (Note 1)
N-Ch 20 V	90 mΩ @ 4.5 V	2.6 A
	125 mΩ @ 2.5 V	2.2 A
P-Ch -20 V	170 mΩ @ -4.5 V	-1.9 A
	300 mΩ @ -2.5 V	-1.0 A

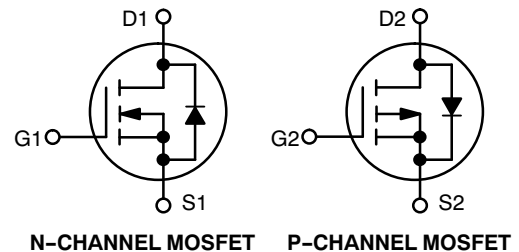

TSOP-6
CASE 318G
STYLE 13

MARKING DIAGRAM

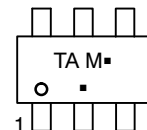

TA = Specific Device Code
M = Date Code
▪ = Pb-Free Package
(Note: Microdot may be in either location)

PIN CONNECTION

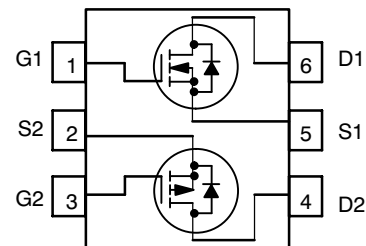

(Top View)

ORDERING INFORMATION

See detailed ordering and shipping information in the package dimensions section on page 9 of this data sheet.

NTGD4167C

ELECTRICAL CHARACTERISTICS (T_J = 25°C unless otherwise noted)

Parameter	Symbol	N/P	Test Conditions	Min	Typ	Max	Unit
OFF CHARACTERISTICS							
Drain-to-Source Breakdown Voltage	V _{(BR)DSS}	N	V _{GS} = 0 V	I _D = 250 μA	30		V
		P		I _D = -250 μA	-30		
Drain-to-Source Breakdown Voltage Temperature Coefficient	V _{(BR)DSS} /T _J	N			21.4		mV/°C
		P			22.2		
Zero Gate Voltage Drain Current	I _{DSS}	N	V _{GS} = 0 V, V _{DS} = 24 V	T _J = 25 °C		1.0	μA
		P	V _{GS} = 0 V, V _{DS} = -24 V			-1.0	
		N	V _{GS} = 0 V, V _{DS} = 24 V	T _J = 85 °C		10	
		P	V _{GS} = 0 V, V _{DS} = -24 V			-10	
Gate-to-Source Leakage Current	I _{GSS}	N	V _{DS} = 0 V, V _{GS} = ±12 V			±100	nA
		P	V _{DS} = 0 V, V _{GS} = ±12 V			±100	

ON CHARACTERISTICS (Note 2)

Gate Threshold Voltage	V _{GS(TH)}	N	V _{GS} = V _{DS}	I _D = 250 μA	0.5	0.9	1.5	V	
		P		I _D = -250 μA	-0.5	-1.1	-1.5		
Drain-to-Source On Resistance	R _{DS(on)}	N	V _{GS} = 4.5 V, I _D = 2.6 A	V _{GS} = 2.5 V, I _D = 2.2 A		52	90	mΩ	
							67		125
		P			V _{GS} = -4.5 V, I _D = -1.9 A		130		170
							V _{GS} = -2.5 V, I _D = -1.0 A		
Forward Transconductance	g _{FS}	N	V _{DS} = 15 V, I _D = 2.6 A		2.6		S		
		P	V _{DS} = -15 V, I _D = -1.9 A		2.6				

CHARGES AND CAPACITANCES

Input Capacitance	C _{ISS}	N	f = 1 MHz, V _{GS} = 0 V	V _{DS} = 15 V		295		pF	
Output Capacitance	C _{OSS}					48			
Reverse Transfer Capacitance	C _{RSS}					27			
Input Capacitance	C _{ISS}			P	V _{DS} = -15 V		419		
Output Capacitance	C _{OSS}						51		
Reverse Transfer Capacitance	C _{RSS}						26		
Total Gate Charge	Q _{G(TOT)}	N	V _{GS} = 4.5 V, V _{DS} = 15 V, I _D = 2.0 A		3.7	5.5	nC		
Threshold Gate Charge	Q _{G(TH)}				0.6				
Gate-to-Source Gate Charge	Q _{GS}				0.9				
Gate-to-Drain "Miller" Charge	Q _{GD}				0.8				
Total Gate Charge	Q _{G(TOT)}	P	V _{GS} = -4.5 V, V _{DS} = -15 V, I _D = -2.0 A		3.9	6.0	nC		
Threshold Gate Charge	Q _{G(TH)}				0.6				
Gate-to-Source Gate Charge	Q _{GS}				1.0				
Gate-to-Drain "Miller" Charge	Q _{GD}				1.0				

SWITCHING CHARACTERISTICS (Note 3)

Turn-On Delay Time	t _{d(ON)}	N	V _{GS} = 4.5 V, V _{DD} = 15 V, I _D = 1.0 A, R _G = 6.0 Ω		7.0		ns
Rise Time	t _r				4.0		
Turn-Off Delay Time	t _{d(OFF)}				14		
Fall Time	t _f				2.0		
Turn-On Delay Time	t _{d(ON)}	P	V _{GS} = -4.5 V, V _{DD} = -15 V, I _D = -1.0 A, R _G = 6.0 Ω		8.0		ns
Rise Time	t _r				8.0		
Turn-Off Delay Time	t _{d(OFF)}				22		
Fall Time	t _f				8.0		

2. Pulse Test: pulse width ≤ 300 μs, duty cycle ≤ 2%.

NTGD4167C

3. Switching characteristics are independent of operating junction temperatures.

ELECTRICAL CHARACTERISTICS ($T_J = 25^\circ\text{C}$ unless otherwise noted)

Parameter	Symbol	N/P	Test Conditions	Min	Typ	Max	Unit
DRAIN-SOURCE DIODE CHARACTERISTICS							
Forward Diode Voltage	V_{SD}	N	$V_{GS} = 0\text{ V}, T_J = 25^\circ\text{C}$	$I_S = 0.9\text{ A}$	0.7	1.2	V
		P		$I_S = -0.9\text{ A}$	-0.8	-1.2	
Reverse Recovery Time	t_{RR}	N	$V_{GS} = 0\text{ V},$ $dI_S / dt = 100\text{ A}/\mu\text{s}, I_S = 0.9\text{ A}$		8.0		ns
Charge Time	t_a				5.0		
Discharge Time	t_b				3.0		
Reverse Recovery Charge	Q_{RR}				3.0		
Reverse Recovery Time	t_{RR}	P	$V_{GS} = 0\text{ V},$ $dI_S / dt = 100\text{ A}/\mu\text{s}, I_S = -0.9\text{ A}$		12		ns
Charge Time	t_a				10		
Discharge Time	t_b				2.0		
Reverse Recovery Charge	Q_{RR}				7.0		

NTGD4167C

N-CHANNEL TYPICAL CHARACTERISTICS

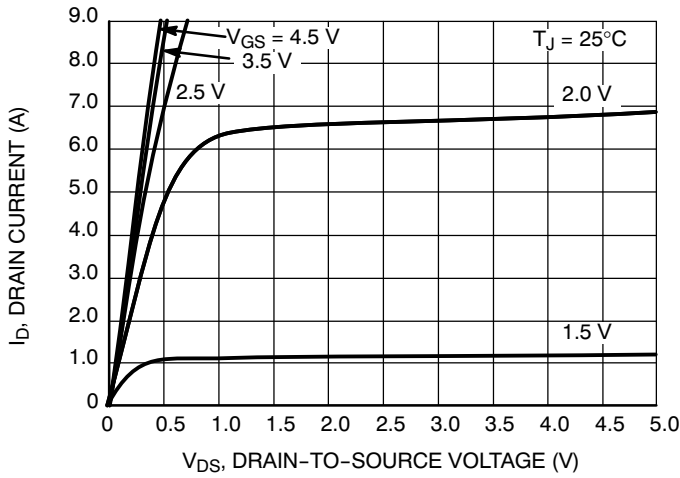

Figure 1. On-Region Characteristics

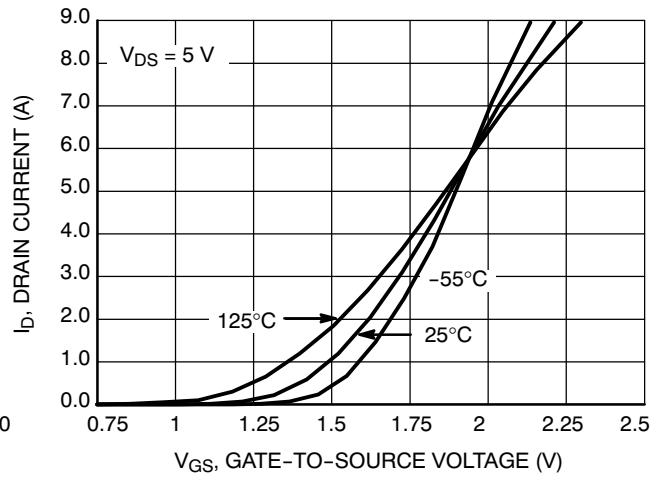

Figure 2. Transfer Characteristics

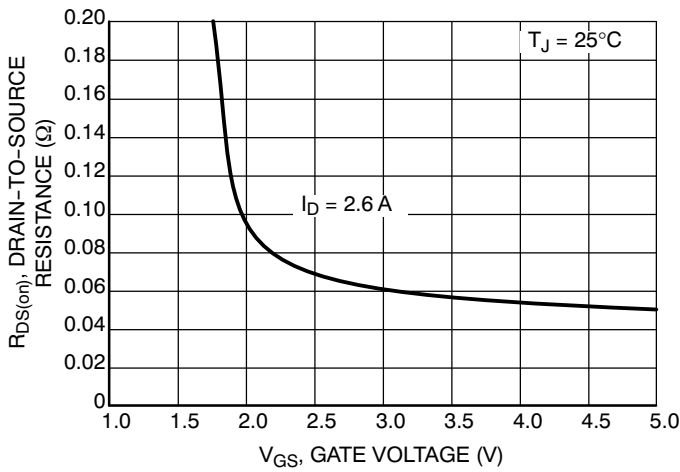

Figure 3. On-Region vs. Gate-to-Source Voltage

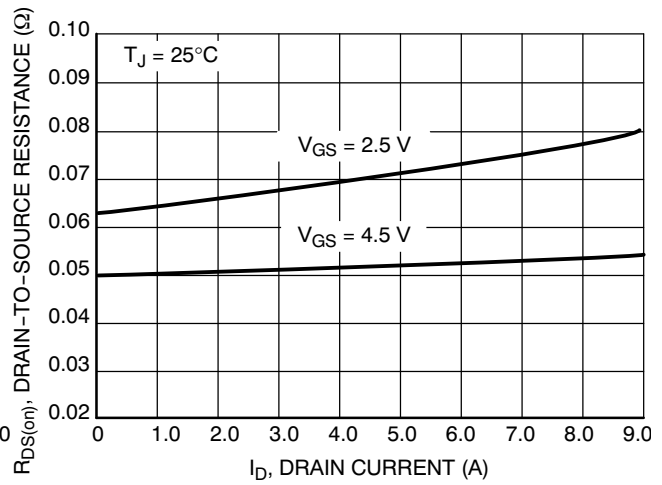

Figure 4. On-Resistance vs. Drain Current and Temperature

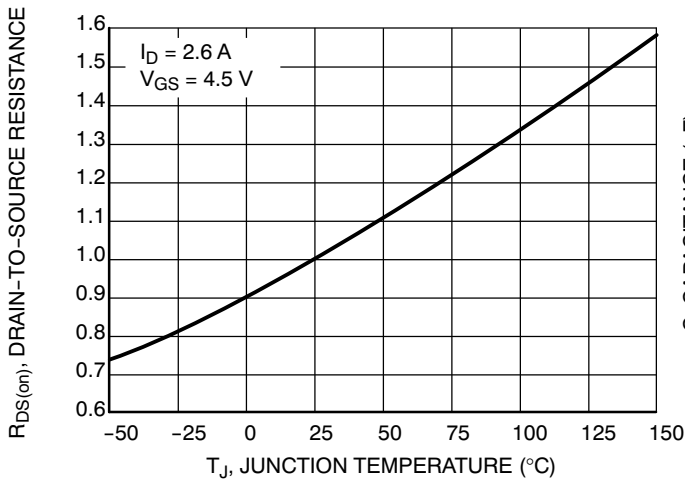

Figure 5. On-Resistance Variation with Temperature

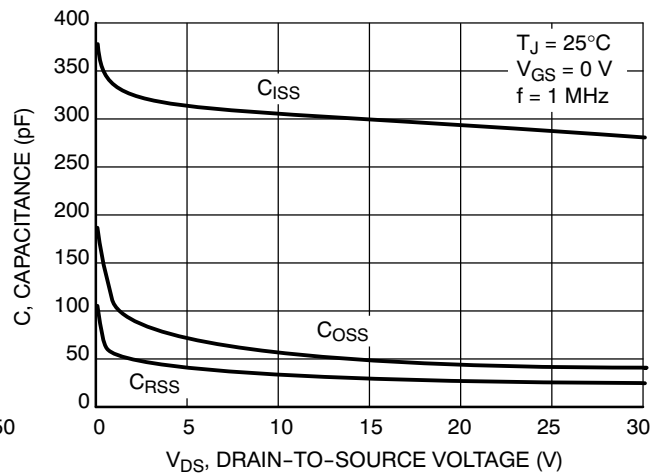

Figure 6. Capacitance Variation

NTGD4167C

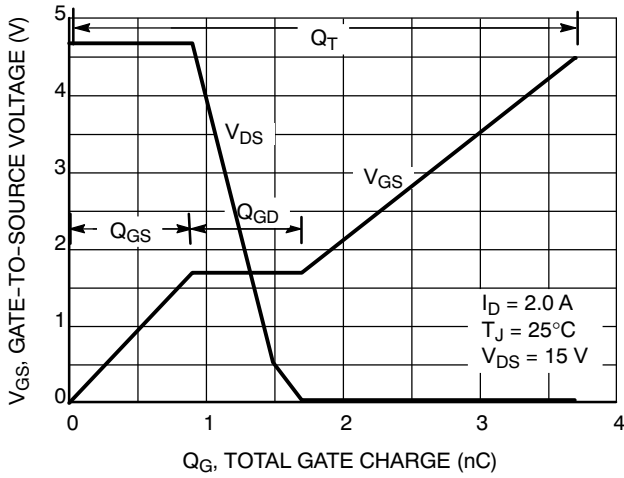

Figure 7. Gate-to-Source and Drain-to-Source Voltage versus Total Charge

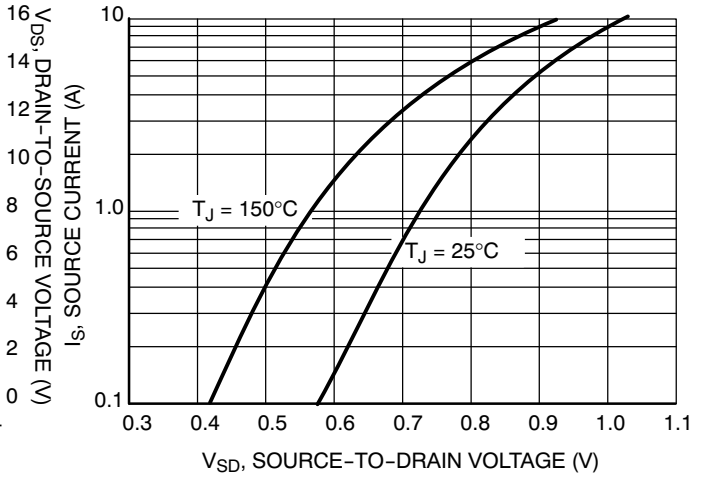

Figure 8. Diode Forward Voltage versus Current

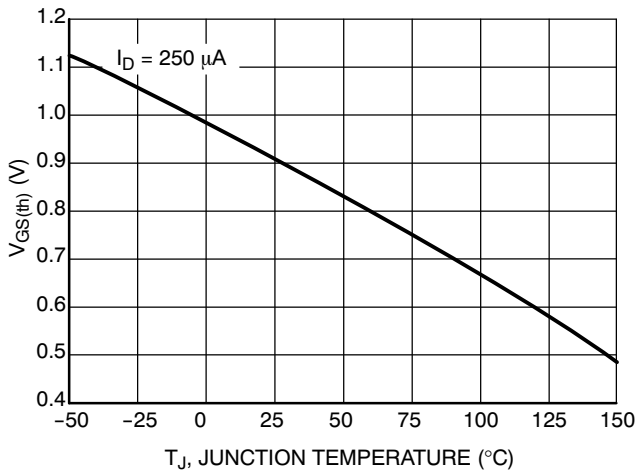

Figure 9. Threshold Voltage

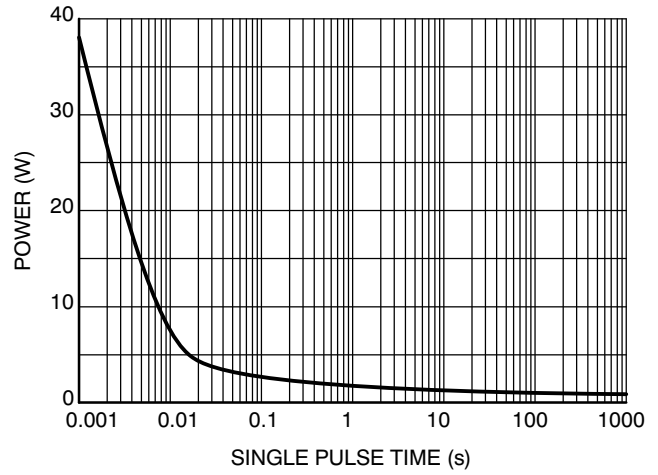

Figure 10. Single Pulse Maximum Power Dissipation

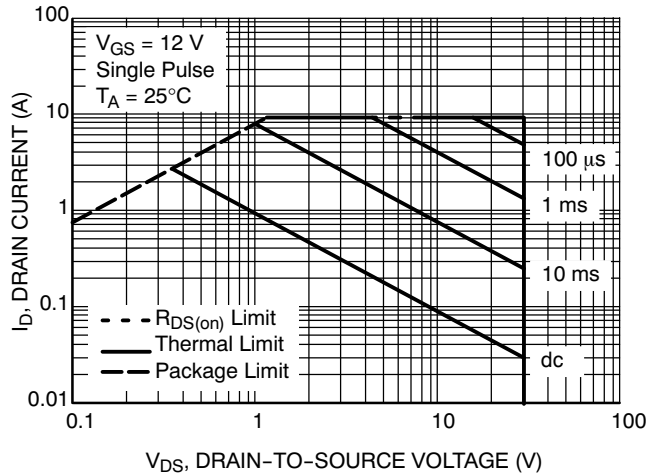

Figure 11. Maximum Rated Forward Biased Safe Operating Area

NTGD4167C

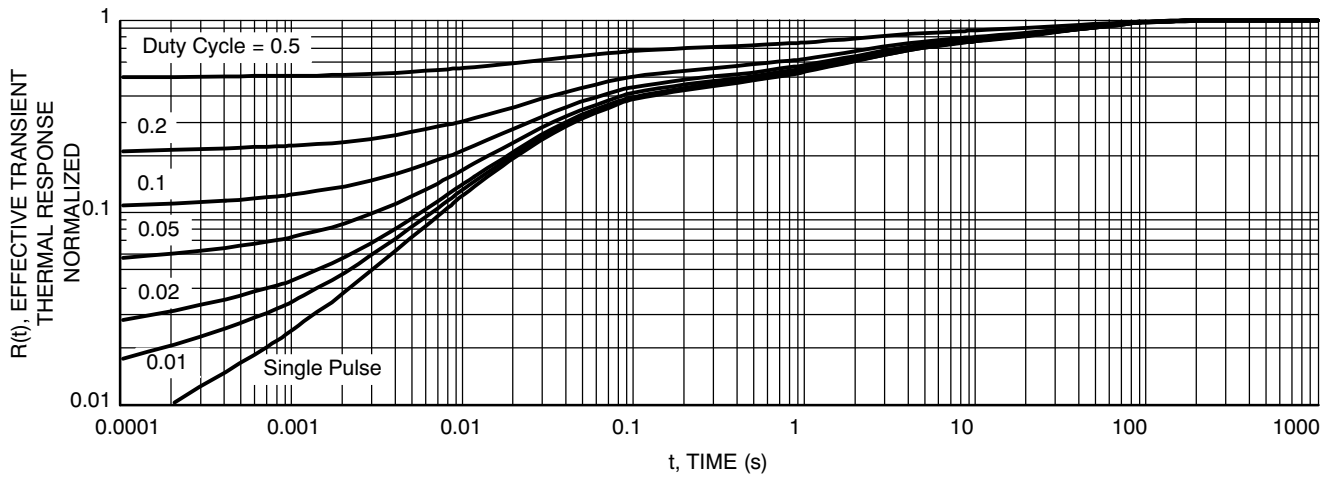

Figure 12. FET Thermal Response

NTGD4167C

P-CHANNEL TYPICAL CHARACTERISTICS

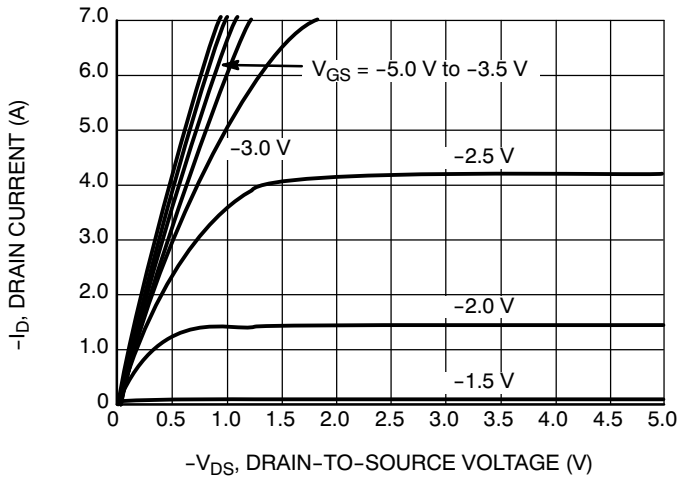

Figure 13. On-Region Characteristics

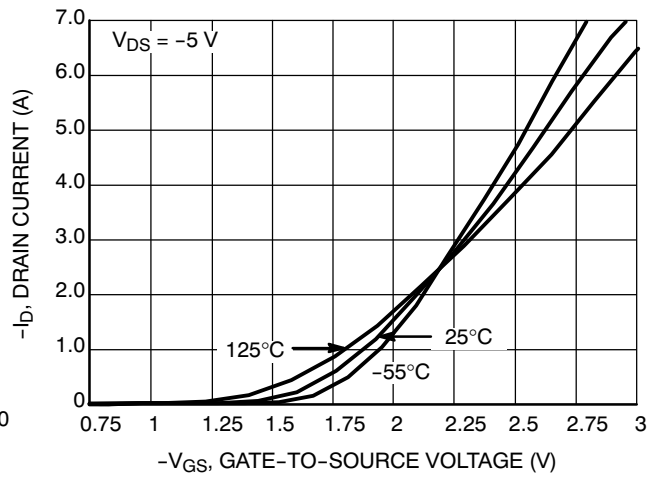

Figure 14. Transfer Characteristics

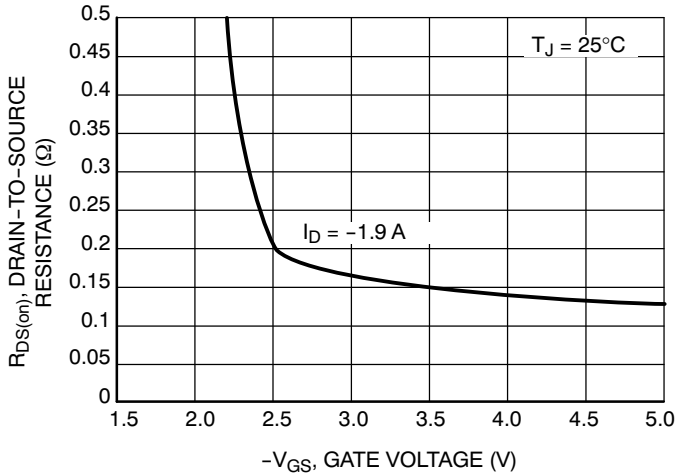

Figure 15. On-Region vs. Gate-to-Source Voltage

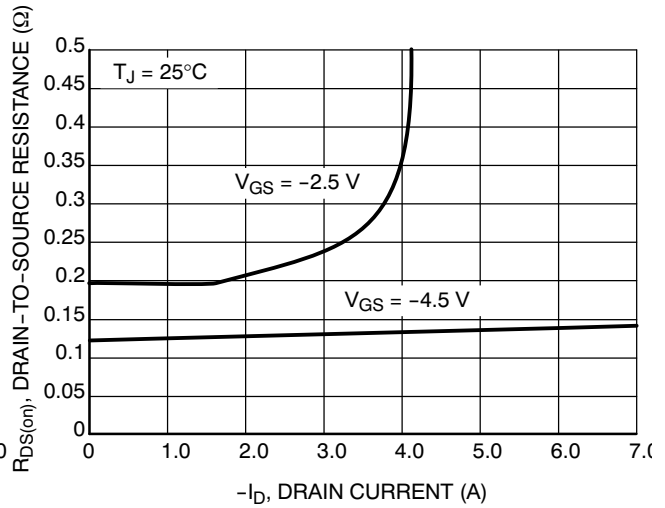

Figure 16. On-Resistance vs. Drain Current and Temperature

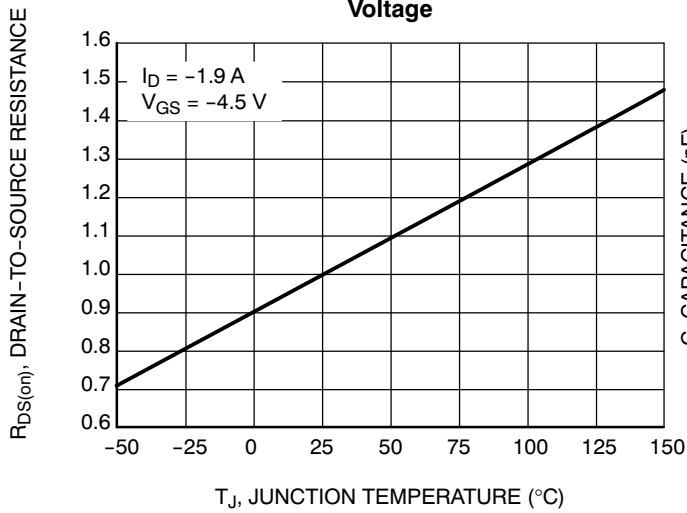

Figure 17. On-Resistance Variation with Temperature

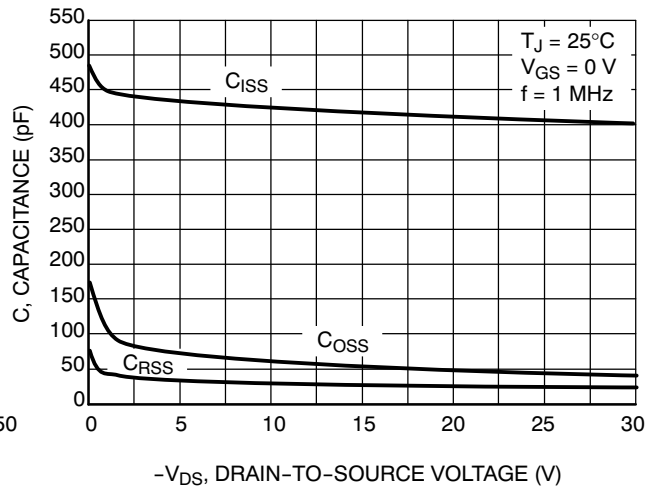

Figure 18. Capacitance Variation

NTGD4167C

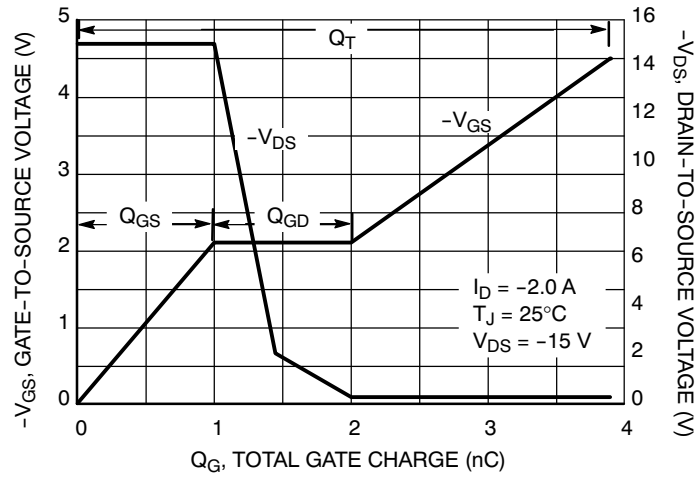

Figure 19. Gate-to-Source and Drain-to-Source Voltage versus Total Charge

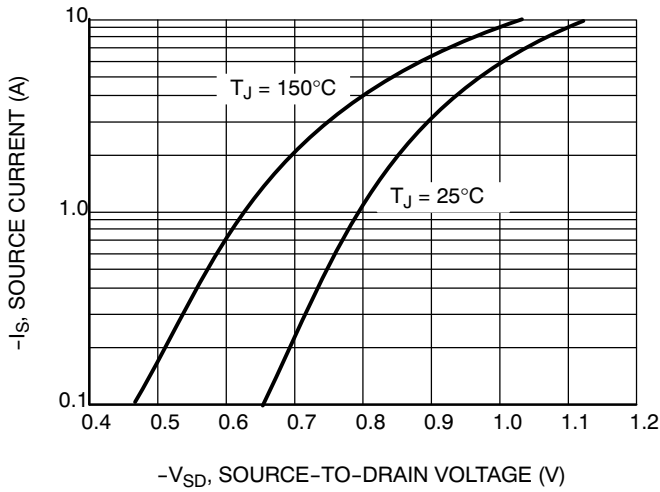

Figure 20. Diode Forward Voltage versus Current

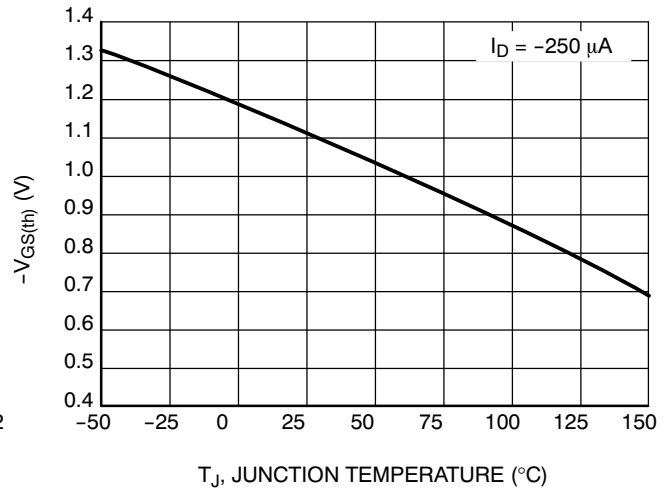

Figure 21. Threshold Voltage

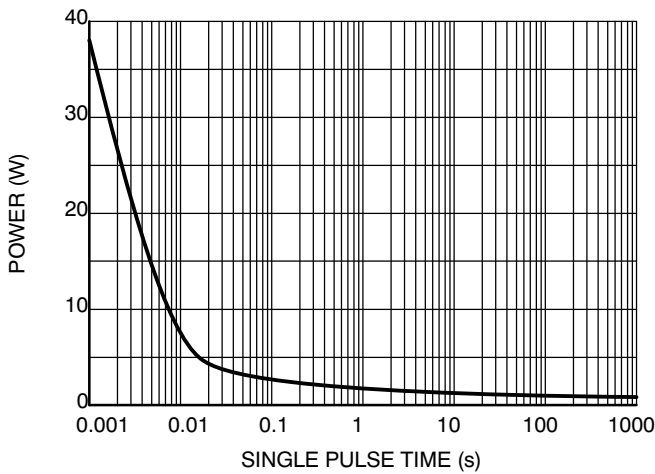

Figure 22. Single Pulse Maximum Power Dissipation

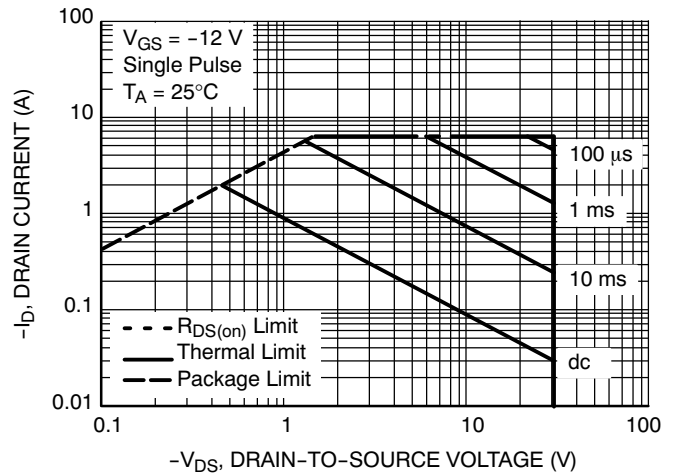

Figure 23. Maximum Rated Forward Biased Safe Operating Area

NTGD4167C

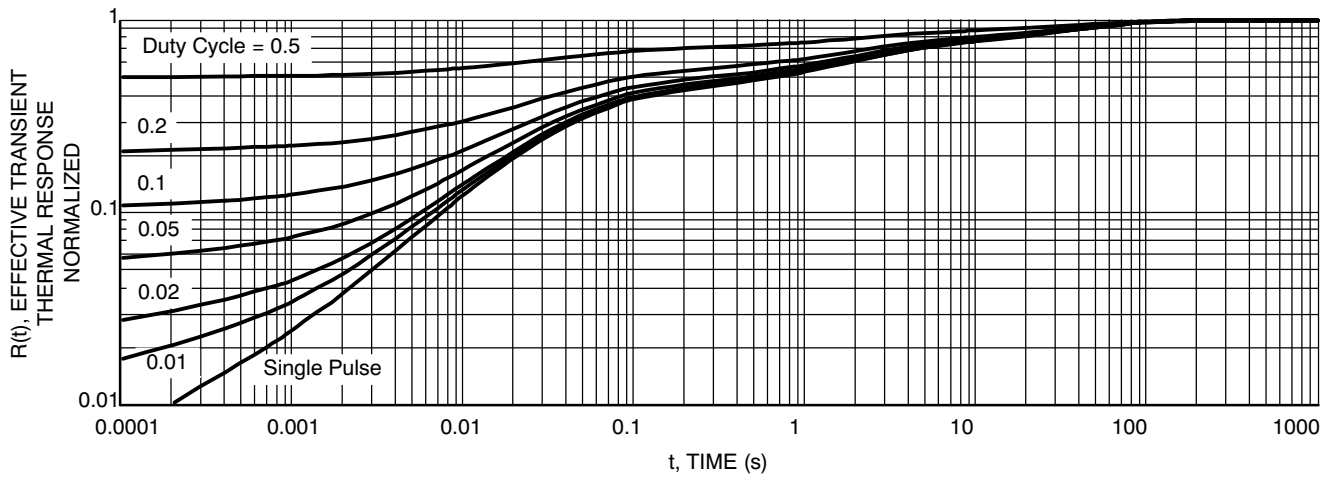

Figure 24. FET Thermal Response

ORDERING INFORMATION

Device	Package	Shipping [†]
NTGD4167CT1G	TSOP6 (Pb-Free)	3000 / Tape & Reel

[†]For information on tape and reel specifications, including part orientation and tape sizes, please refer to our Tape and Reel Packaging Specifications Brochure, BRD8011/D.

NTGD4167C

PACKAGE DIMENSIONS

TSOP-6
CASE 318G-02
ISSUE S

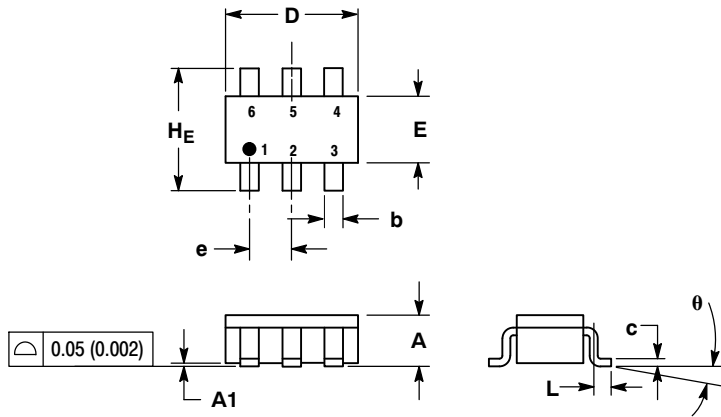

NOTES:

1. DIMENSIONING AND TOLERANCING PER ANSI Y14.5M, 1982.
2. CONTROLLING DIMENSION: MILLIMETER.
3. MAXIMUM LEAD THICKNESS INCLUDES LEAD FINISH THICKNESS. MINIMUM LEAD THICKNESS IS THE MINIMUM THICKNESS OF BASE MATERIAL.
4. DIMENSIONS A AND B DO NOT INCLUDE MOLD FLASH, PROTRUSIONS, OR GATE BURRS.

DIM	MILLIMETERS			INCHES		
	MIN	NOM	MAX	MIN	NOM	MAX
A	0.90	1.00	1.10	0.035	0.039	0.043
A1	0.01	0.06	0.10	0.001	0.002	0.004
b	0.25	0.38	0.50	0.010	0.014	0.020
c	0.10	0.18	0.26	0.004	0.007	0.010
D	2.90	3.00	3.10	0.114	0.118	0.122
E	1.30	1.50	1.70	0.051	0.059	0.067
e	0.85	0.95	1.05	0.034	0.037	0.041
L	0.20	0.40	0.60	0.008	0.016	0.024
HE	2.50	2.75	3.00	0.099	0.108	0.118
θ	0°	-	10°	0°	-	10°

STYLE 13:

- PIN 1. GATE 1
2. SOURCE 2
3. GATE 2
4. DRAIN 2
5. SOURCE 1
6. DRAIN 1

SOLDERING FOOTPRINT*

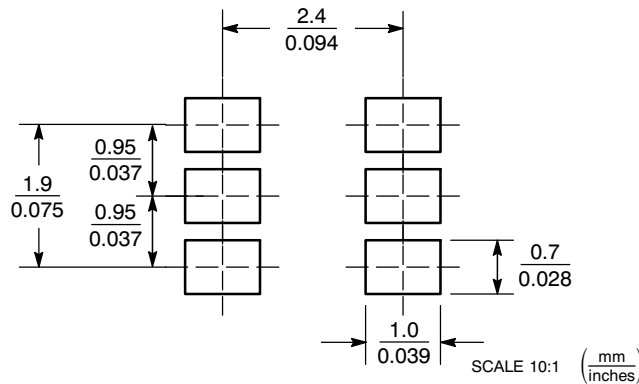

*For additional information on our Pb-Free strategy and soldering details, please download the ON Semiconductor Soldering and Mounting Techniques Reference Manual, SOLDERRM/D.

ON Semiconductor and are registered trademarks of Semiconductor Components Industries, LLC (SCILLC). SCILLC reserves the right to make changes without further notice to any products herein. SCILLC makes no warranty, representation or guarantee regarding the suitability of its products for any particular purpose, nor does SCILLC assume any liability arising out of the application or use of any product or circuit, and specifically disclaims any and all liability, including without limitation special, consequential or incidental damages. "Typical" parameters which may be provided in SCILLC data sheets and/or specifications can and do vary in different applications and actual performance may vary over time. All operating parameters, including "Typicals" must be validated for each customer application by customer's technical experts. SCILLC does not convey any license under its patent rights nor the rights of others. SCILLC products are not designed, intended, or authorized for use as components in systems intended for surgical implant into the body, or other applications intended to support or sustain life, or for any other application in which the failure of the SCILLC product could create a situation where personal injury or death may occur. Should Buyer purchase or use SCILLC products for any such unintended or unauthorized application, Buyer shall indemnify and hold SCILLC and its officers, employees, subsidiaries, affiliates, and distributors harmless against all claims, costs, damages, and expenses, and reasonable attorney fees arising out of, directly or indirectly, any claim of personal injury or death associated with such unintended or unauthorized use, even if such claim alleges that SCILLC was negligent regarding the design or manufacture of the part. SCILLC is an Equal Opportunity/Affirmative Action Employer. This literature is subject to all applicable copyright laws and is not for resale in any manner.

PUBLICATION ORDERING INFORMATION

LITERATURE FULFILLMENT:
Literature Distribution Center for ON Semiconductor
P.O. Box 61312, Phoenix, Arizona 85082-1312 USA
Phone: 480-829-7710 or 800-344-3860 Toll Free USA/Canada
Fax: 480-829-7709 or 800-344-3867 Toll Free USA/Canada
Email: orderlit@onsemi.com

N. American Technical Support: 800-282-9855 Toll Free USA/Canada
Japan: ON Semiconductor, Japan Customer Focus Center
2-9-1 Kamimeguro, Meguro-ku, Tokyo, Japan 153-0051
Phone: 81-3-5773-3850

ON Semiconductor Website: <http://onsemi.com>
Order Literature: <http://www.onsemi.com/litorder>

For additional information, please contact your local Sales Representative.